

SINCE 1854

Esse 301 & 350 SE

**LOW EMISSIONS
INSET SOLID FUEL
CONVECTOR ROOMHEATERS**

v50 of 09/11/2010

INSTALLATION AND OPERATING INSTRUCTIONS LEAVE THIS DOCUMENT WITH THE HOUSEHOLDER!

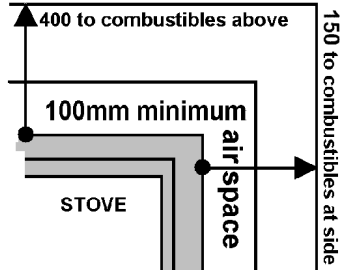
	<p>This Esse stove exceeds the safety and performance requirements of European Standard EN13229-2001 Independently tested by SGS.(Notified laboratory No: 0608) in 2010. Intermittent burning solid fuel roomheaters for installation with a single dedicated chimney.</p>				
	350		301		
	Wood logs	Anthracite	Wood logs	Anthracite	
	Mean flue temperature	246°C	235°C	230°C	269°C
	Mean CO in flue (as if at 13% O2)	0.20%	0.08%	0.14%	0.09%
	Efficiency	80%	77%	83%	78%
	Nominal Output	5.2kW	6.5kW	4.1kW	3.6kW
	Minimum air entry	3300 mm ²		2700 mm ²	
	Minimum air space around fire	Back = 0mm, Sides + Top = 100mm			
	Minimum clearance to combustible materials	For installation in masonry fireplace, clearance to combustibles at top: 400mm, at sides and back: 150mm			

Manufactured by Esse Engineering
The Ouzledale Foundry, Long Ing, Barnoldswick, Lancashire BB18 6BN, England
www.esse.com

Read these instructions! Use only recommended fuels!

<p>This document, when completed by the installer, constitutes part of a 'Hearth Notice' for purposes of Building Law. It must be left with the householder and placed where it can easily be found. INSTALLED AT LOCATION:</p> <p>BY: _____</p> <p>EMERGENCY CONTACT: _____</p> <p>I definitively assert that this installation is safe, has been lit and demonstrated to the householder, conforms with current building regulations and with these instructions</p> <p>SIGNED: _____ DATE: _____</p>	<p>Flue Draught measured on commissioning:</p> <div style="border: 1px solid black; width: 100px; height: 30px; margin: 0 auto;"></div> Pa WG <p>Fuel used on commissioning</p> <div style="border: 1px solid black; width: 100px; height: 30px; margin: 0 auto;"></div>
--	---

TO FIND A QUALIFIED INSTALLER, FUEL SUPPLIER or CHIMNEY SWEEP, CONTACT:
UK: The Solid Fuel Association, 7 Swanwick Court, Alfreton, Derbyshire DE55 7AS Tel:0845-601-4406 www.solidfuel.co.uk
Rol: Irish Nationwide Fireplace Organisation, 162 Capel Street, Dublin 1 Tel:01-801-5959 www.fireplace.ie

Esse 301 & 350 SE may be used in smoke control areas when operated strictly in accordance with these instructions, when burning:
UK: Untreated wood logs, natural anthracite or smokeless fuels (*Exempted from s20 of the Clean Air Act 1993*)
Rol: Wood logs, smokeless fuels or peat briquettes, but *not* petroleum coke (*Control of Atmospheric Pollution Regulations, 1970*)



Welcome to your new Esse...

...and to joining the illustrious tribe of Esse fire-keepers, along with, over more than one hundred and fifty years; Florence Nightingale, Captain Scott, Mrs Beeton, Auguste Escoffier and most of the Royal Families of Europe.

THIS APPLIANCE BECOMES EXTREMELY HOT AND CAN PRODUCE POISONOUS GASES.

A fire-guard should be used if children or the infirm are present. The installer is required to EXACTLY follow these instructions and to comply with all local, national and applicable international standards.

This document is a guide to installing and using this Esse heating stove, the installer must understand and comply with all local, national and European standards and regulations.

ASBESTOS: The Esse does not contain asbestos, but take care to avoid disturbing any asbestos in an old installation.

WEIGHT this Esse is heavy (86 kg+) - protect your spine by moving the stove only with assistance. Ensure that the intended fireplace can support this weight- consider fitting a load distributing plate if necessary.

YOUR CHIMNEY...

...creates the draught which makes your Esse work - it must:

- Generate a draught in use of at least 12Pa (0.05ins wg)
- Be capable of withstanding the temperatures generated.
- Be incapable of leaking fumes into the dwelling

This will commonly be achieved by it:

- Being at least 5m high.
- Terminating at least 1m above any roof ridge.
- Having an internal cross-section not less than 0.018m² (eg 150mm dia) and never more than 0.14m² (eg 375 x 375mm)
- Being free from even the slightest crack or source of leakage.
- Having no bends sharper than 45°.
- Being entirely free of obstructions and swept by a qualified chimney sweep.
- Being connected only to this one appliance.
- Being of masonry or otherwise adequately insulated.
- Conforming to local building regulations.

Special rules apply where the flue passes through timber, thatch or other vulnerable materials- take specialist advice.

AIR SUPPLY: Your stove needs air to breathe - there must be a permanent fresh air supply into the space in which it is installed equal to the size given on page 1. This may sometimes be provided by air leaking around door frames etc. (it is commonly accepted that this alone may suffice for appliances <c.5KW) but in any case of doubt, fit a purpose-made air vent. An extractor fan, or another fuel-using appliance in the same building, can remove this air.

FITTING: The stove is to be fitted into fireplaces, which must

- Be made of fireproof materials, eg brick, tile, stone, iron.
- Have a hearth at least 125mm thick (which may include the thickness of a solid floor) extending at least 225mm in front of the appliance and 125mm to each side.
- Be capable of withstanding the very high temperatures generated by this appliance.
- Have free space of at least 100mm for air to circulate at the top, front and sides around the in-room parts of the appliance.

FITTING FRAME A metal fitting frame is available

CHIMNEY SWEEPING: Although it is often possible to sweep the chimney through the fire with the throat plate removed, consider fitting cleaning hatches to provide access if needed.

FITTING TO FLUE PIPE OR

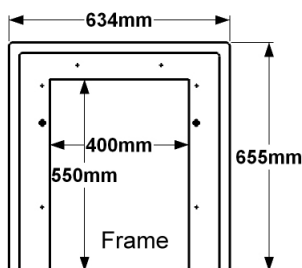

LINERS A round flue-pipe adaptor is available to connect to standard 150mm flue pipe. The adaptor can be sealed to the pipe or liner (fitted with a standard 150mm adaptor) with fire cement *before* inserting the stove in its fireplace, the adaptor is then smeared with fire cement and screwed to the stove outlet from inside.

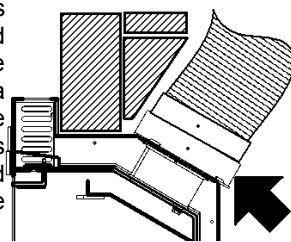

FITTING: THE 'ENGLISH' METHOD

These Esse models can fit straight into a standard British or Irish fireplace conforming to BS1251 & BS8303. The fireplace can be of any shape, but will always:

- Have an opening width (A) of between 400 and 420mm,
- An opening height (B) of between 540 and 560mm,
- A flat area (C) extending 70mm around the opening
- Have a hearth extending at least 300mm (D), without obstructions to prevent the door opening.

(The fireplace will become VERY hot - Where thin slabs of mineral material (marble, limestone etc) are used to face a fireplace, we recommend using 5 separate panels, as shown, to allow for differential expansion.)

The 301 model will fit directly into any correctly constructed

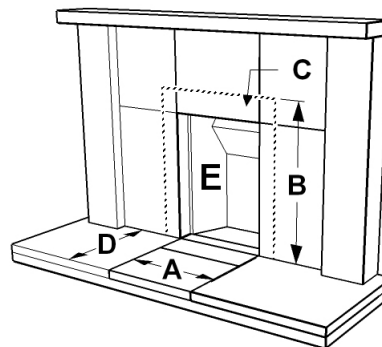

fireplace with the fireback (E) in place. The larger 350 model requires the fireback to be broken up and removed, so that a clear, level depth of at least 260mm is available.

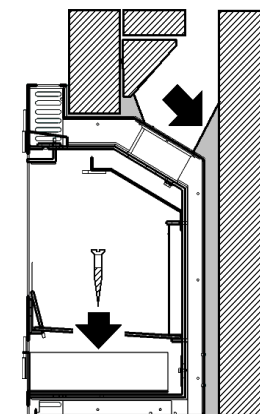

Fit a soft fibre seal against the back of the in-room part of the stove using the adhesive tape supplied. Place the appliance on the hearth and push it fully into the fireplace so that the seal is compressed forming an **absolutely** airtight seal against the fireplace.

301 only: Fasten the top screw clamp so that it grips the inside of the fireplace lintel.

Both models: Screw the stove firmly in place through the fixing hole(s) in the base of the firebox. (Additional fixing, if needed, is into the fireplace surround, through the two holes towards the top

right and left of the fuelling opening)

These Esse stoves are double-cased - it is not necessary to fill any *small* gap behind the appliance - larger gaps should be filled with rubble, vermiculite granules or mineral fibre wool.

It is highly advisable, where fitted into a masonry flue without a metal liner, to form a smooth mortar flaunching between the flue outlet and the flue. With care, this can be done through the flue outlet.

THE 'RUSSIAN' METHOD

The stove is fitted into a free-standing chamber built from firebricks, often decorated with tiles, slate or marble panels. This

not only collects extra heat, but acts as a storage heater, continuing to warm the room long after the fire has died down.

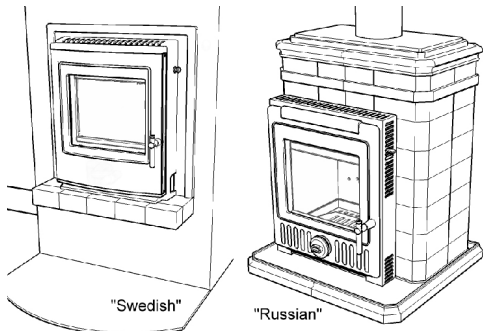

THE 'FRENCH' METHOD

The stove is fitted into a hollow chimney breast which has air openings at top and bottom to transfer additional heat by convection from the long, uninsulated, flue pipe. This method gives higher efficiency and quicker warm-up, but thereby reduces the heat given into the chimney so that great care must be taken to ensure that adequate draught is maintained.

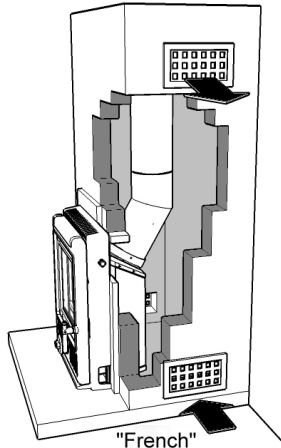

THE 'SWEDISH' METHOD

The stove is fitted in the 'English' or 'French' method, but at height, providing easier access and greater visibility. The stove is supported on a masonry shelf (a pressed concrete paving slab surfaced with tiles is ideal). Use of the fitting frame is recommended. Having the stove at least 400mm above will provide the necessary clearance from a combustible floor, which can be protected from stray sparks by, for instance, a glass floor protector.

CHECK THE INSTALLATION !

Once installed, light the fire, demonstrate it to the householder and check that:

- 1) It burns controllably and does not emit fumes to the room
- 2) The route for gases from the stove to the chimney terminal is **completely** airtight, unobstructed and able to be swept.
- 3) The entire construction is of durable fireproof materials.
- 4) The flue presents a draught in use of at least 12Pa
- 5) Fit a CO alarm !

LIVING WITH YOUR ESSE

Every fuel, chimney and condition of use is different. Only experience will show which are the best settings for you.

LIGHTING If you're lighting the fire after a period of non-use, do check the chimney for blockages first! Empty the ashes. Place two or three firelighters *close together*, or screwed-up paper covered with very dry sticks, at the back of the grate and light them. When they are burning well gently fill the fire very full, just up to the level of the top of the firebox liners, with dry fuel, close the door and set the air control to the 'high' position.

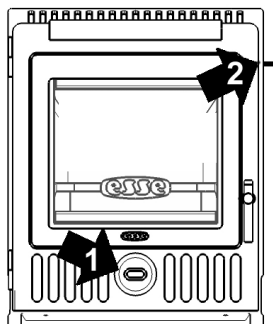

CONTROL How fast the fire burns depends on how much air reaches the fuel. The stove has two air controls, one below the window ('primary' ①) and one above ('airwash control' ②), which is moved to the right for highest output, to the left for 'low'.

When burning wood **always keep (1) closed** and adjust the burn using (2). When burning mineral fuels like anthracite or synthetic smokeless fuels, control the fire with (1) and keep (2) almost closed.

The best settings will depend on your fuel, air supply and flue draught and can only be found from experience.

EMPTYING ASHES use the tool or glove to open the door. Stir the fire with a poker and use the tool to lift out the ashpan. Remember to let ash cool before disposing in plastic sacks or dustbins. There is no need to empty every last speck, but ash should never be allowed to build up so that it comes into contact with the underside of the grate.

EXTENDED BURNING Allow the fire to burn down to a low, hot firebed. Empty the ash and fully fill with hard fuel such as anthracite (c30mm size is best). Set the air control to 'low'.

CLEANING Wipe the stove body with a slightly damp cloth when cool, don't use abrasives, metal polish or 'cream' cleansers as they can scratch the surface. NEVER use aerosol sprays near the hot fire – they can ignite.

KEEPING THE WINDOW CLEAN With most fuels the window will require no cleaning other than an occasional wipe with a dry cloth. Simply operating the stove for a few minutes at high output will usually burn-off any deposits left by tarry or wet fuels. Severe stains can be removed with a proprietary cleaner. After a period of use tiny hairline cracks may appear on the window, this is not a fault, but is characteristic of the toughest and most heat-resistant material currently available. Reduce the risk of staining by using only **very dry fuel** and having the airwash control (top right) always *slightly* open (ie, out)

OPENING THE DOOR this Esse is designed to be operated only with the door closed. Open the door slowly to minimise fume emission and prevent hot fuel falling out.

FUELS

Different fuels will perform differently with different chimneys and air supply situations. There is no 'perfect' fuel for every situation, so we strongly recommend that you try a selection of fuels (or mixtures) to find which suits you best.

WOOD When wood is cut down its cells are full of water. Burning such wet or 'green' wood wastes heat in making steam and produces flammable, acidic tars which will cling to, and can damage, your stove and chimney. Logs should be split lengthways and dried for at least a year. The fine, white residue produced when wood burns is not ash, but the remains of cell walls which can burn if kept hot enough, so don't de-ash a wood fire until *absolutely* necessary.

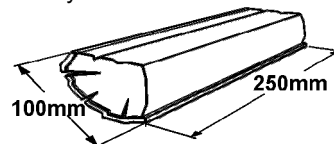

Minimise smoke emission from wood by:

- Split logs lengthways for drying
- Use logs no bigger than about 100mm x 250mm
- Ensure logs are *absolutely dry* (less than 15% moisture)
- Fill the stove criss-cross, so air can circulate between logs.
- Fill 'little and often'
- Always have the airwash control (2) at least a little open.
- When first lighting, or reviving a fire from embers, use only very small, thin, dry, sticks.

JOINERY WASTE Dry wood offcuts will burn well, but don't expect softwood waste to burn as cleanly or for as long as hardwood logs.

HOUSECOAL (or BITUMINOUS COAL) (Not smokeless) Makes lots of tarry smoke which will stain the window and large volumes of flammable gas which make it difficult to control and risk explosions. Despite its low cost, it rarely represents value for money. Don't use housecoal.

ANTHRACITE and DRY STEAM COAL (Smokeless) Are natural hard, shiny forms of coal. Slow to light, they burn with great heat and last a long time. Choose the 'small nuts' size.

LIGNITE is a natural mineral, between peat and coal. It lights easily and burns well, though some varieties produce much ash

BRIQUETTES Are compressed blocks of fuel, generally able to burn for long periods and remarkable for their consistency. 'Homefire' and 'Phurnacite' are smokeless types while other brands are made from lignite, peat or housecoal.

PETROLEUM COKE sold as 'Petcoke', 'Longbeach' and under various proprietary names, is made from oil. Easy to light and to control, its exceptional heat and lack of protective ash mean that it

is **MUST NOT** be used unless mixed with another fuel. Grate and liner life will be drastically reduced when using petroleum coke **HOUSEHOLD WASTES** Some plastics give off toxic fumes when burned and remember that batteries and aerosols explode! this Esse is not an incinerator, so only ever use the recommended fuels and **NEVER** use liquid fuels in any form.

SUMMER SHUT DOWN: Before a long period of non-use, empty fuel and ash, remove the throat plate and leave all the air controls open to allow ventilation to reduce condensation.

PROBLEMS?

Problems like those listed here are due to some difficulty with the installation, chimney or fuels, so please check back through this leaflet carefully. If necessary seek specialist advice.

SMOKE FROM THE CHIMNEY It is quite normal for a little smoke to be emitted from the chimney when the fire is cold. Use only **VERY** dry wood or smokeless fuels and take care to follow the instructions about 'control' earlier in this document.

HEAT OUTPUT A stove can heat a typical room of *about* 12m³ volume for each kW of output, so a 5kW model can heat up to (12 x 5) 63m³, a room of about 5m square. The actual size depends on the insulation and air-change ratio of the room. To attempt to heat a larger room will result in excessive fuel consumption and damaging overheating.

LACK OF CONTROLLABILITY Wood and some other fuels may burn excessively until the gases in them have been used up. You can reduce this effect by making sure that the fire is set to 'low' for a while before refuelling and checking that the door seals fully.

DIFFICULTY BURNING FOR EXTENDED PERIODS These appliances are designed to burn wood quite rapidly in order to eliminate dangerous smoke emissions. For extended burning, use hard mineral fuels like natural anthracite. If the fire goes out with fuel still in the firebox, then this is probably because too little air has been reaching it, try leaving the air controls open a little more. Check that the door seals are sound and that there are no cracks or gaps anywhere in the flue. For longest burning, we recommend hard fuels such as anthracite.

SMOKE COMING INTO ROOM Fumes are poisonous- smoke emission must **NEVER** be tolerated, causes might be:

INADEQUATE SEALS: Check that an inset appliances is fully sealed against the fireplace. Even the tiniest crack or gap can spoil the draught.

BLOCKED THROAT PLATE: Has soot and ash can collected on

the 'throat plate' above the inner back part of the firebox? See the 'maintainance' section.

UNSUITABLE, BLOCKED OR UN-SWEPT CHIMNEY: The first requirement for correct operation is a sound chimney. Check the requirements earlier in this document and in any case of doubt have the chimney professionally swept.

POOR AIR SUPPLY: Is there enough air? Lack of air to the fire is a common cause of smoking and poor performance. Air supply problems may be worse in certain wind conditions (often incorrectly ascribed to 'downdraught', which is in fact very rare), where air can be sucked out of the room. The answer is to fit an air vent, as near to the fire as possible, facing into the usual wind direction.

DOWNDRAUGHT: Wind can blow *down* a chimney if there is something higher nearby such as a tree, hill or high building. Fitting an anti-downdraught cowl to the chimney top can cure this. Types which cannot be swept through are not recommended.

POOR CHIMNEY DRAUGHT- Chimney draught in use **MUST** be at least 12Pa.

CHIMNEY FIRE: In the rare event of deposits inside the chimney igniting (roaring sound + dense smoke and sparks from the chimney) immediately close the door, shut all air controls and call the fire brigade. Prevent fires by using **very dry fuel** and having your chimney swept regularly.

MAINTENANCE

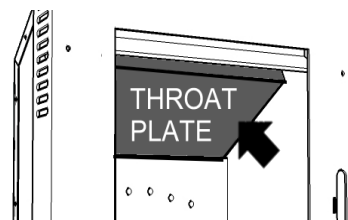

MONTHLY- With the fire cold, remove, clean and refit the throat plate (or 'baffle plate') fitted below the flue outlet. Check that the flue is clear and unblocked, and that the door seals are sound.

ANNUALLY- **SWEEP THE CHIMNEY** The entire length of the chimney from stove to outlet should be swept annually, or more often if smoky fuels are used.

NEW PARTS this Esse has been extensively tested for safety - please don't try to modify it and always make sure to obtain genuine spare parts.

PARTS AND ACCESSORIES

ALTERNATIVE DOORS

Any Esse 301 and 350 model can be fitted with any door front from an extensive range of styles and colours.

WEARABLE PARTS

- (a) Throat plate (state 301 or 350)
 - (b) Liner Set (state 301 or 350)
 - (c) Grate with front bar (both models)
 - (d) Ashpan (state 301 or 350)
 - (f) Grate Infil (350 only)
- not shown:
 Rope seal - door to body
 Transparent Window
 Operating tool

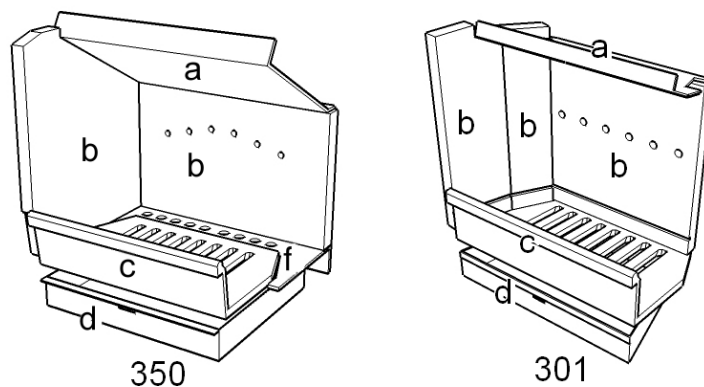

Your Esse is guaranteed (excluding wearable parts) for one year from the date of purchase, in addition to your statutory rights.